

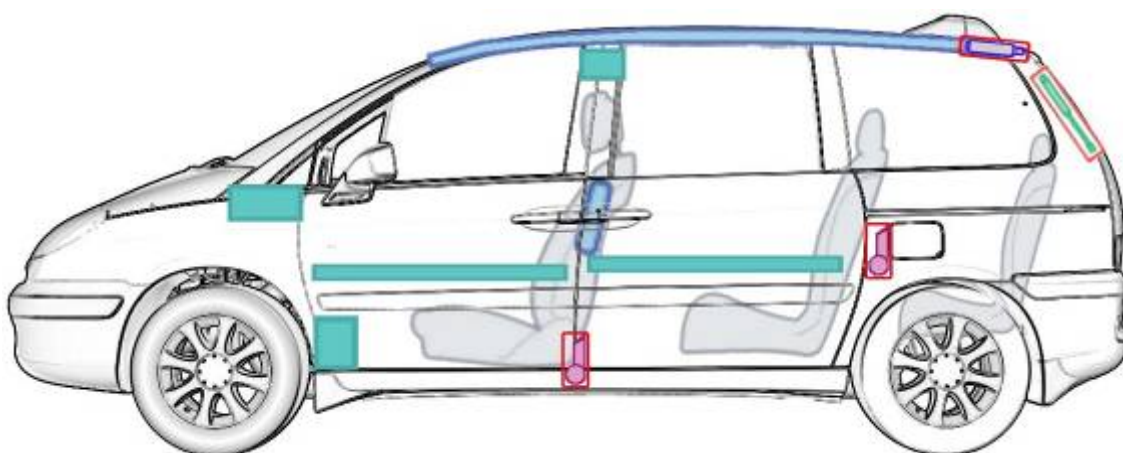

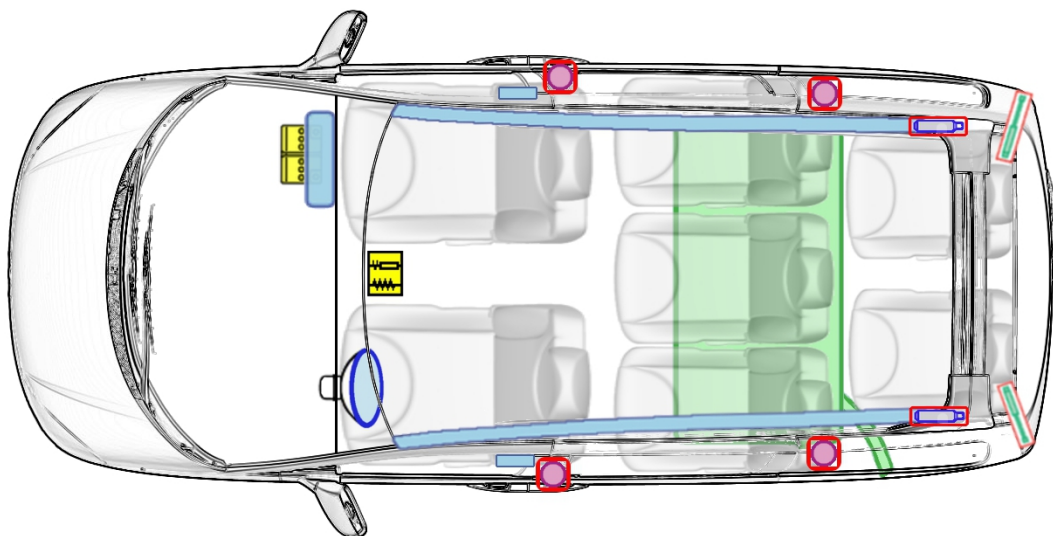







Peugeot 807 (ab 2002)



Legende

	Airbag		Karosserie- verstärkung		Batterie		Steuergerät
	Gas- generator		Gurtstraffer		Überroll- schutz		Gasdruck- dämpfer
	Gastank		Sicherheits- ventil		Kraftstoff- tank		e-Booster
	Sicherungs- kasten		Hochvolt -leitung/ -komponenten		Hochvolt -batterie		Hochvolt- trennstelle